

Ax8



Bx8



Cx1



Dx1



Ex1



Fx1



Gx1

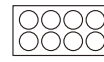

Hx1



Ix1



Jx1

1

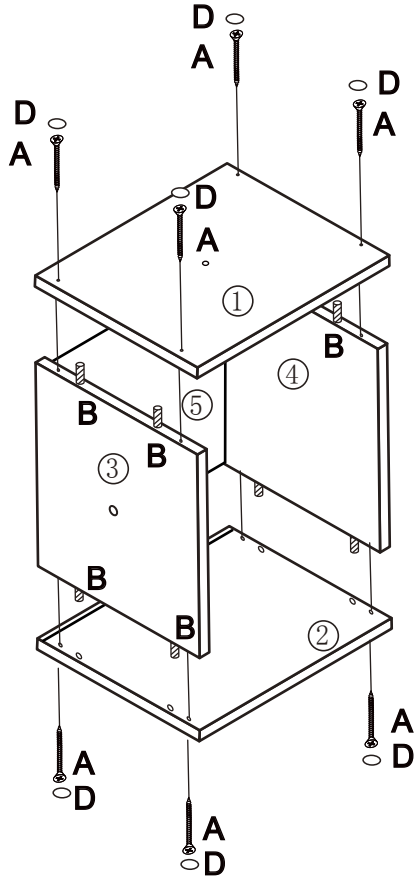

2

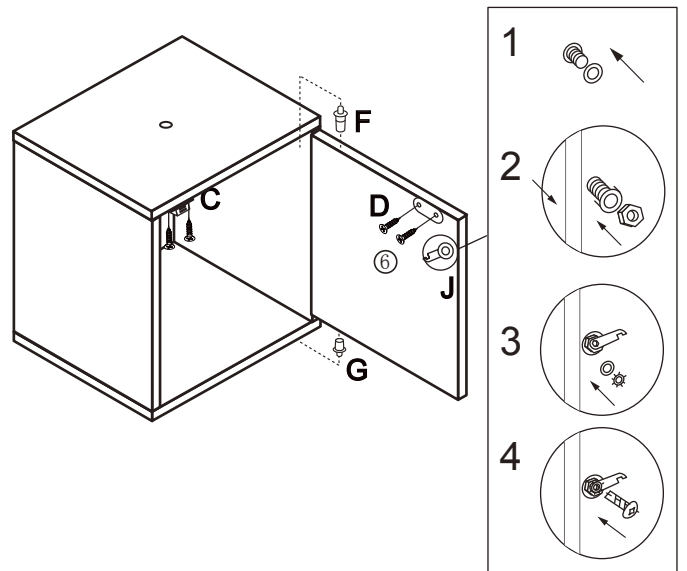

3

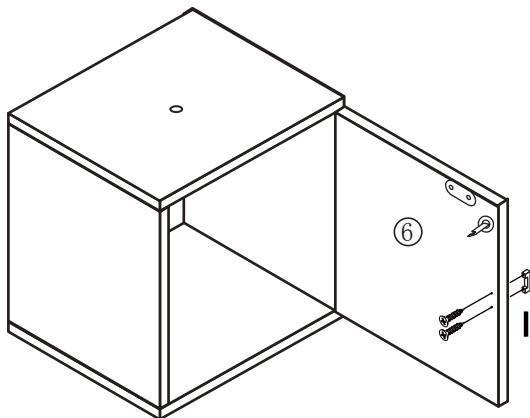

4

