











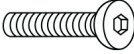

|  |  |   |   |  |
|--|--|---|---|--|
| <br><b>Ax1</b>        | <br><b>Bx1</b>        | <br><b>Cx1</b> | <br><b>6x12mm Dx4</b> | <br><b>6x14mm Ex4</b> |
| <br><b>6x16mm Fx4</b> | <br><b>6x16mm Gx4</b> | <br><b>Hx1</b> |   |  |

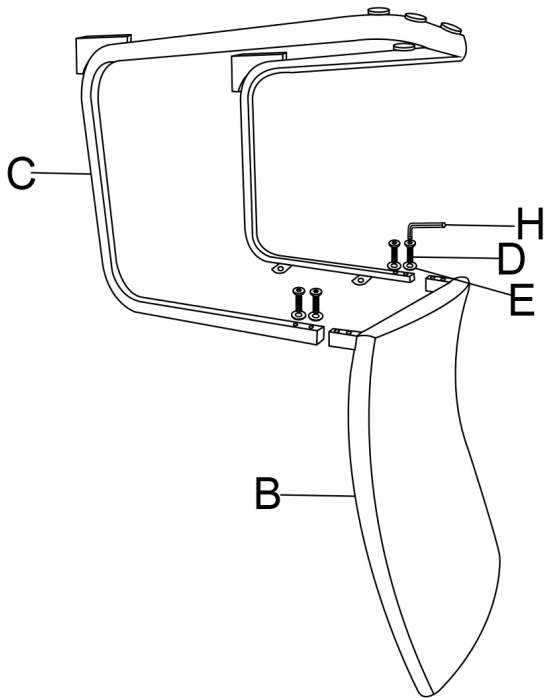





# 1

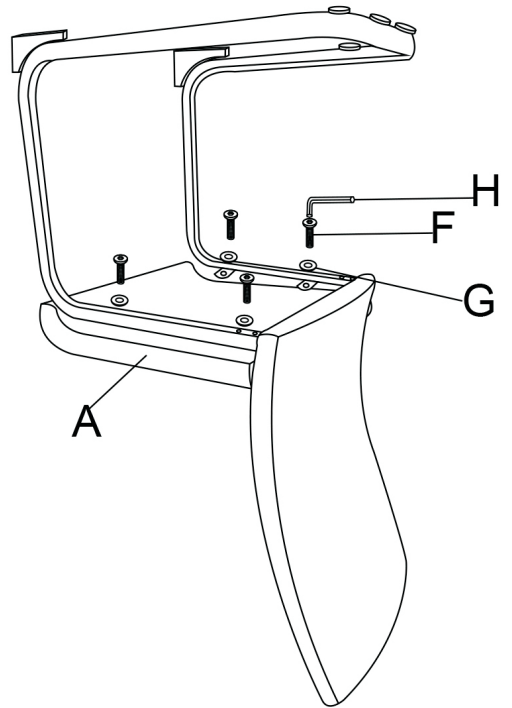

|   |   |   |
|---|---|---|
| <br>Bx1          | <br>Cx1      | <br>6x12mm Dx4 |
| <br>6x14mm Ex4 | <br>M5 Hx1 |   |

# 2



|   |   |   |
|---|---|---|
| <br>Ax1      | <br>6x16mm Fx1 | <br>6x16mm Gx4 |
| <br>M5 Hx1 |   |   |

# 3

